

Edge Detail

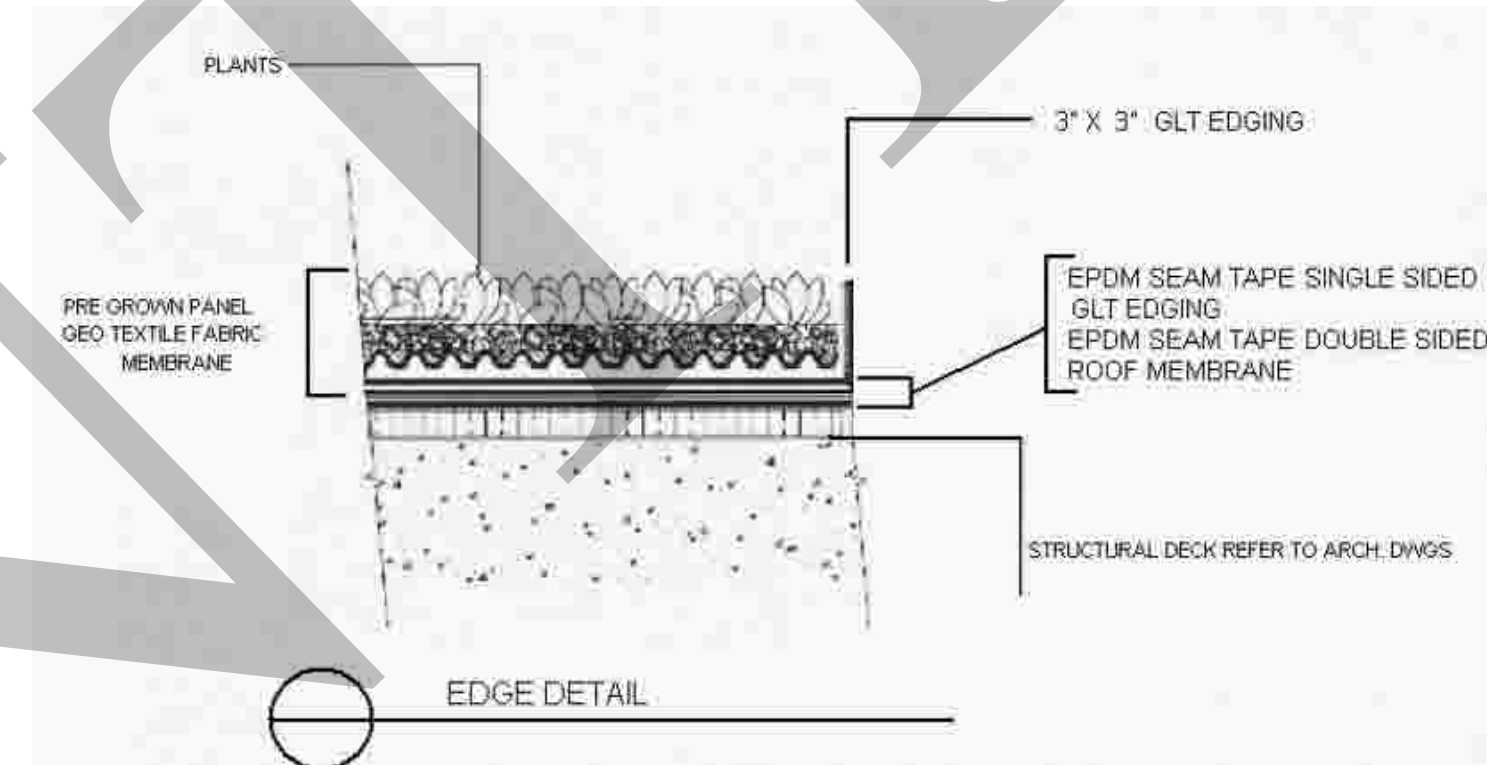

1. Prime surfaces with EPDM primer *Prime both the membrane and the edging
2. Install 3" double sided seam tape
3. Press edging into the top of seam tape
4. Use a 6" cover tape to secure the edging.

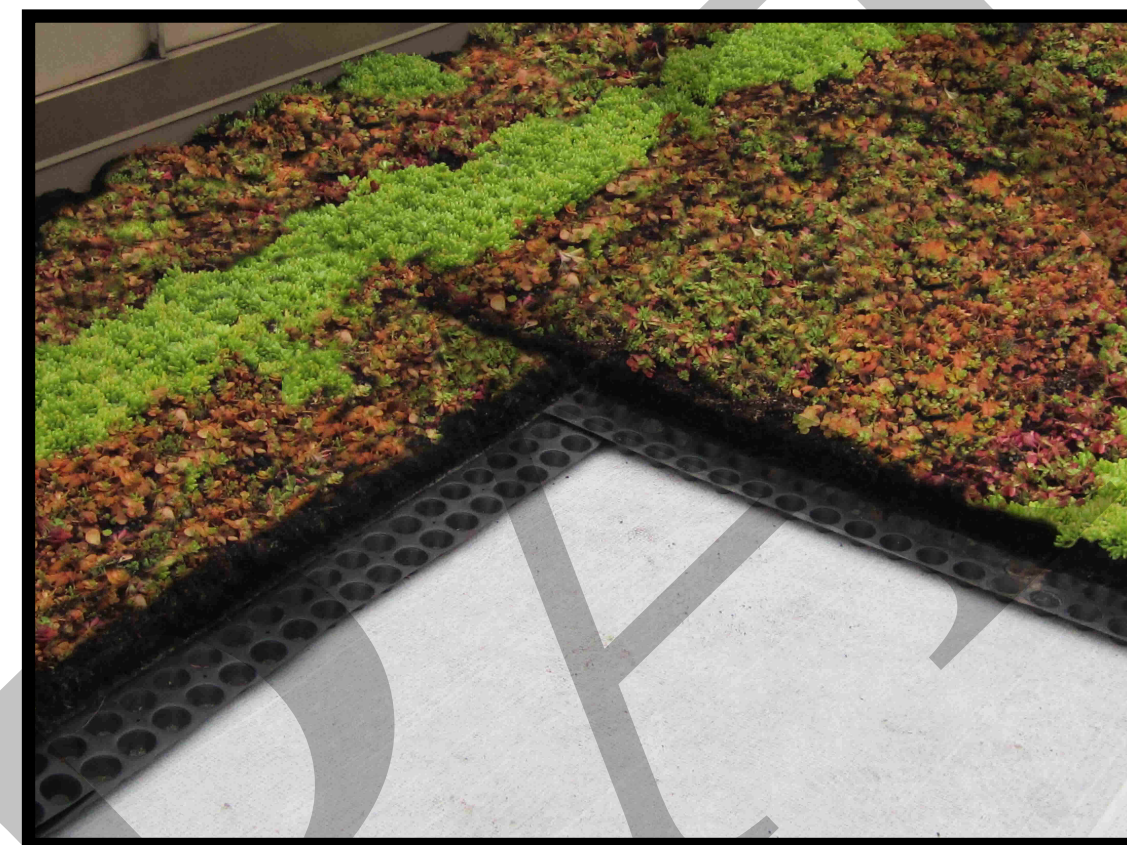

Clean Roof Deck

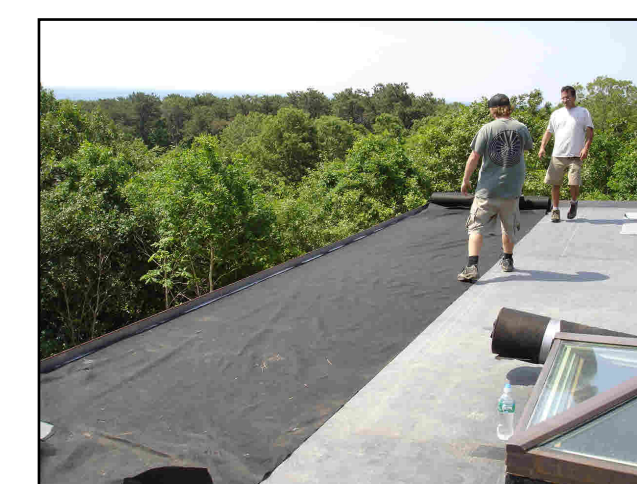

Slip Sheet per spec



Install Panels

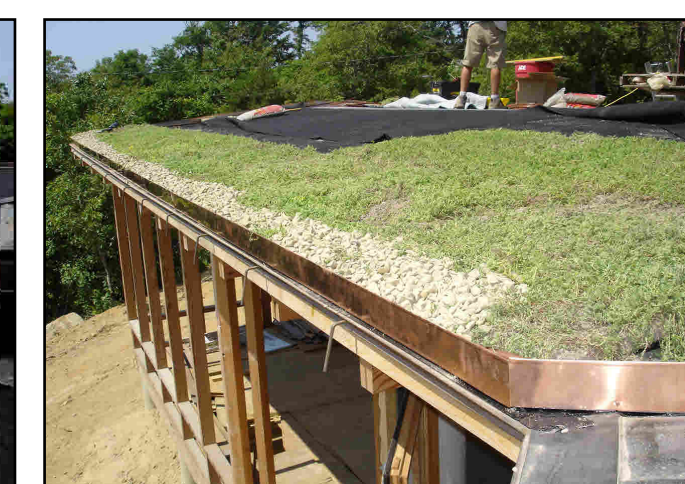

3/4 clean stone as ballast edge
*Option pending detail

By:
GLT International, LLC
1151 Titus Avenue Ste 1
Rochester New York 14617
www.agreenroof.com 800-631-8001

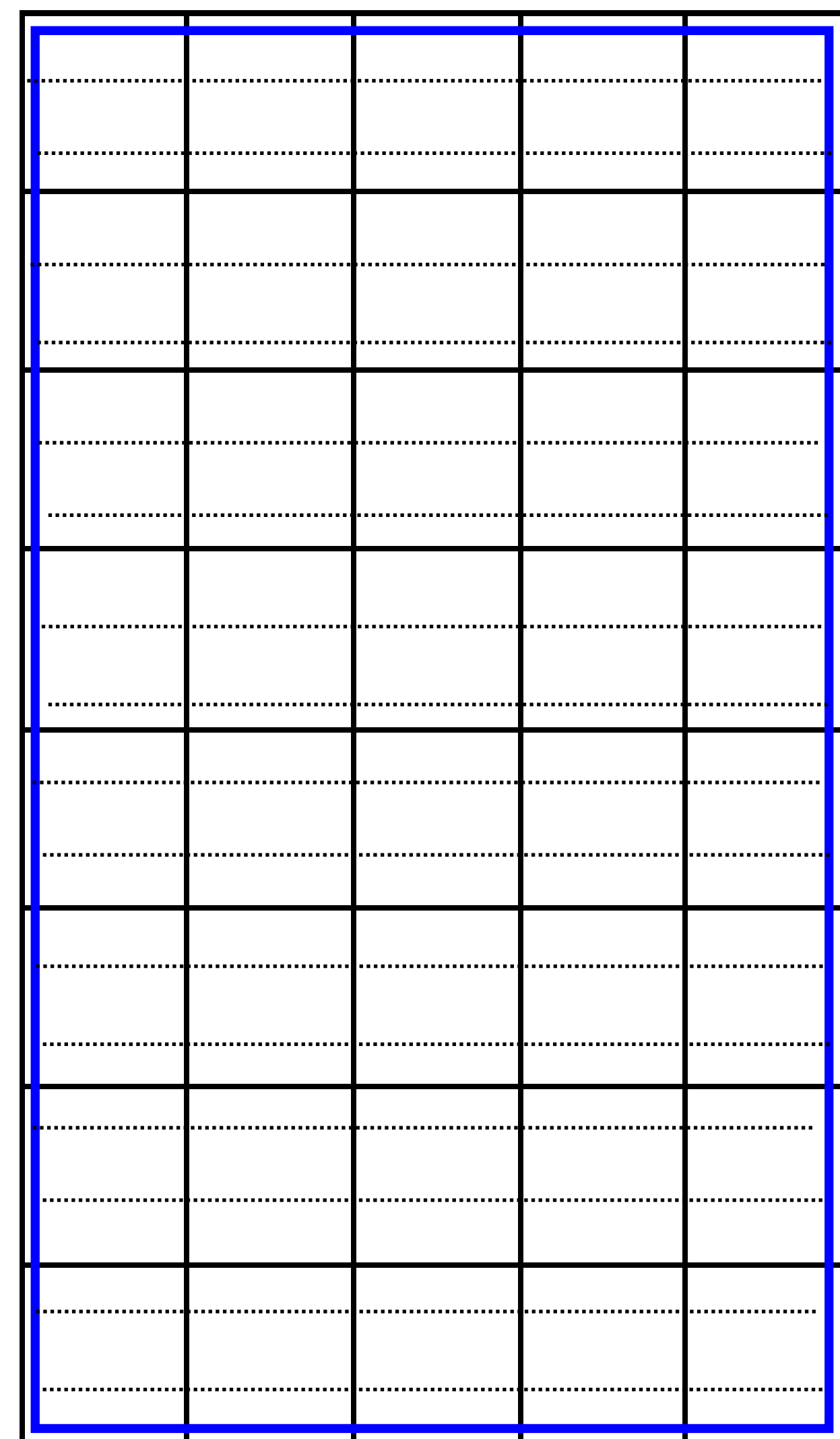
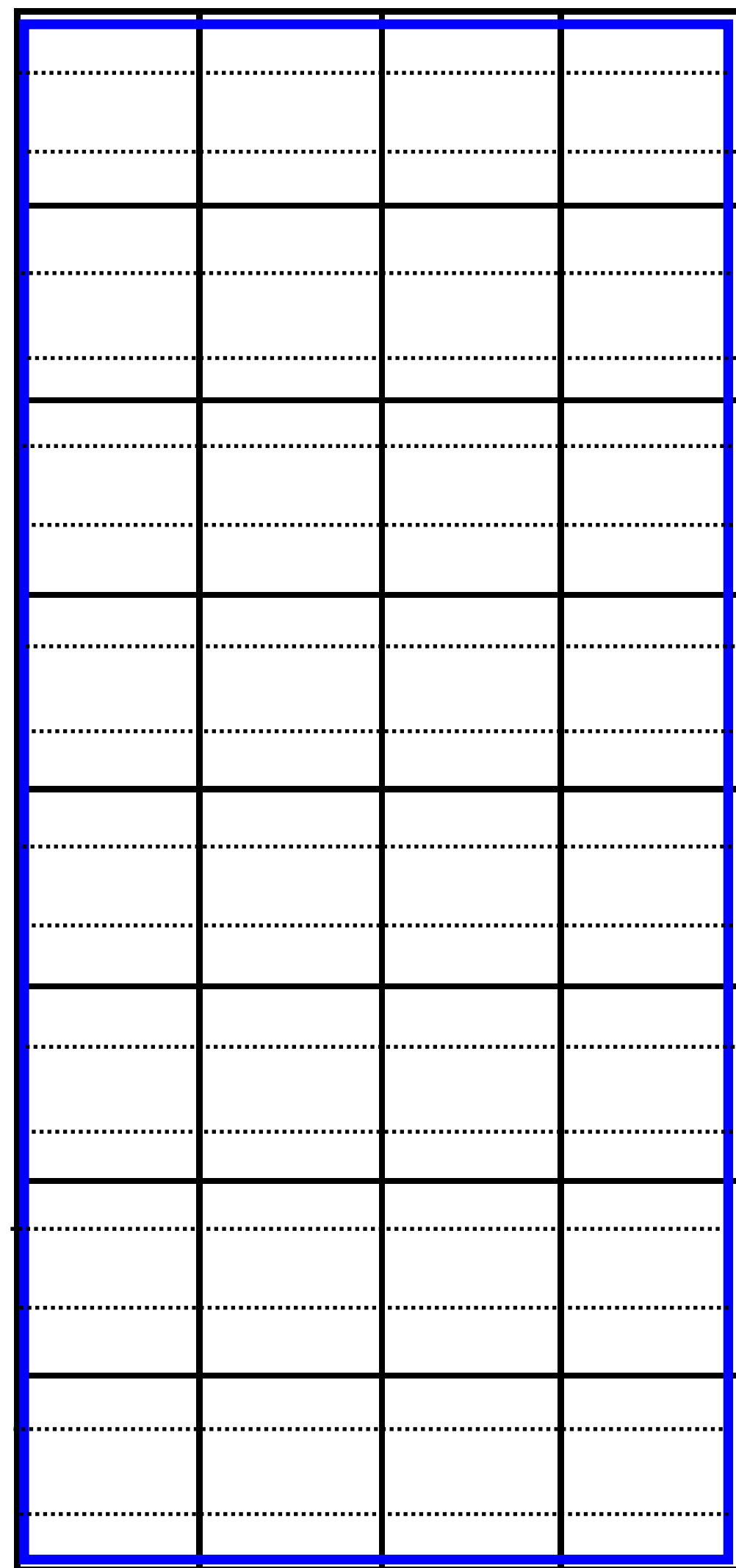

OPTIONAL IRRIGATION

GENERAL NOTES

1. - ALL IRRIGATION MAINLINES AND LATERALS ARE SHOWN OUTSIDE THE EDGING OR BALLASTS FOR GRAPHIC CLARITY ONLY. ALL MAINLINES SHALL BE LOCATED INSIDE THE EDGING ADJACENT TO TRAYS AND/OR WITHIN THE BALLAST MATERIAL AS INDICATED ON CONSTRUCTION DETAILS.

OPTIONAL BATTERY OPERATED CONTROLLER

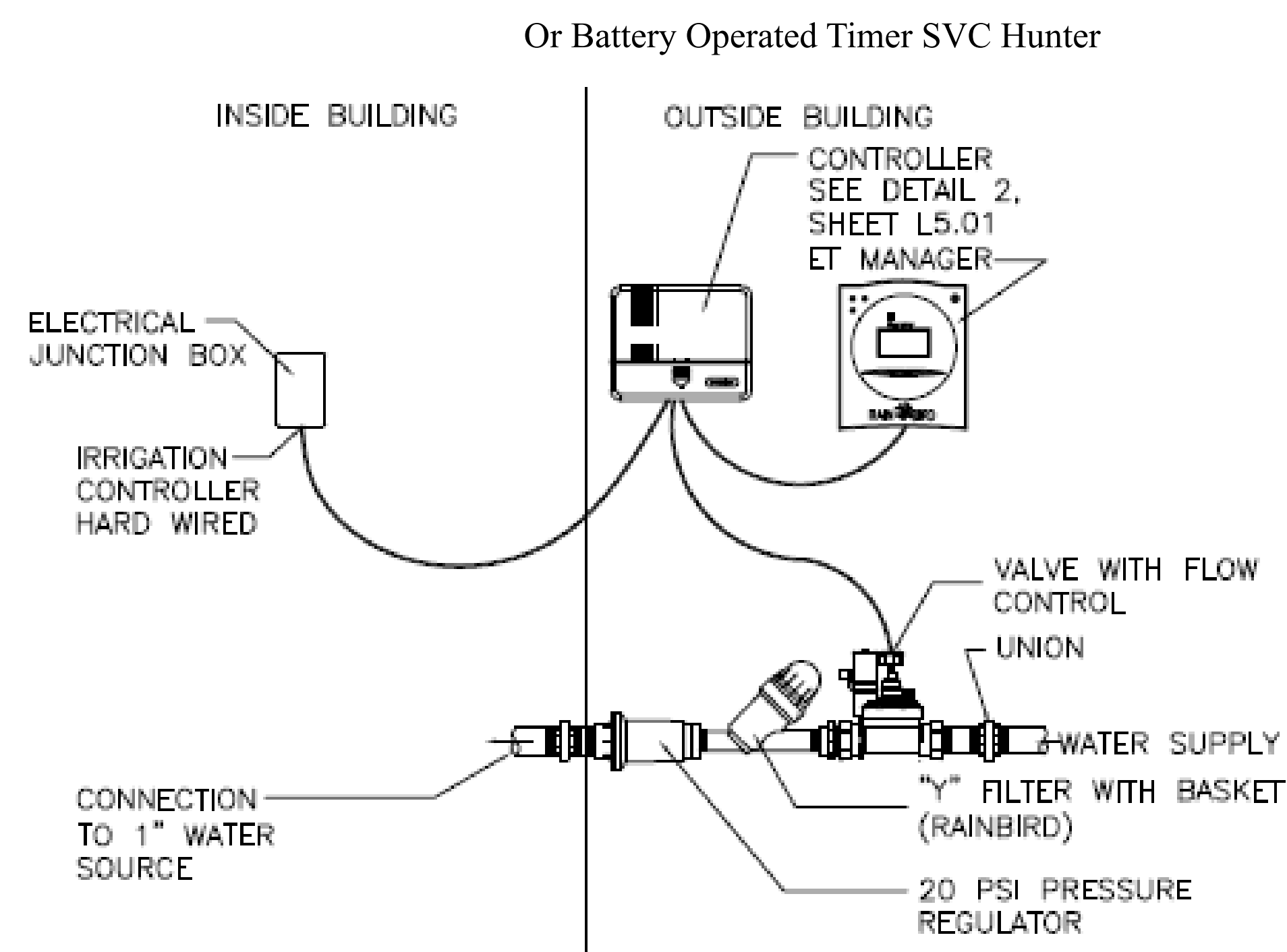

1 CONTROLLER AND ET SYSTEM TO VALVE ELECTRICAL CONNECTION
NTS

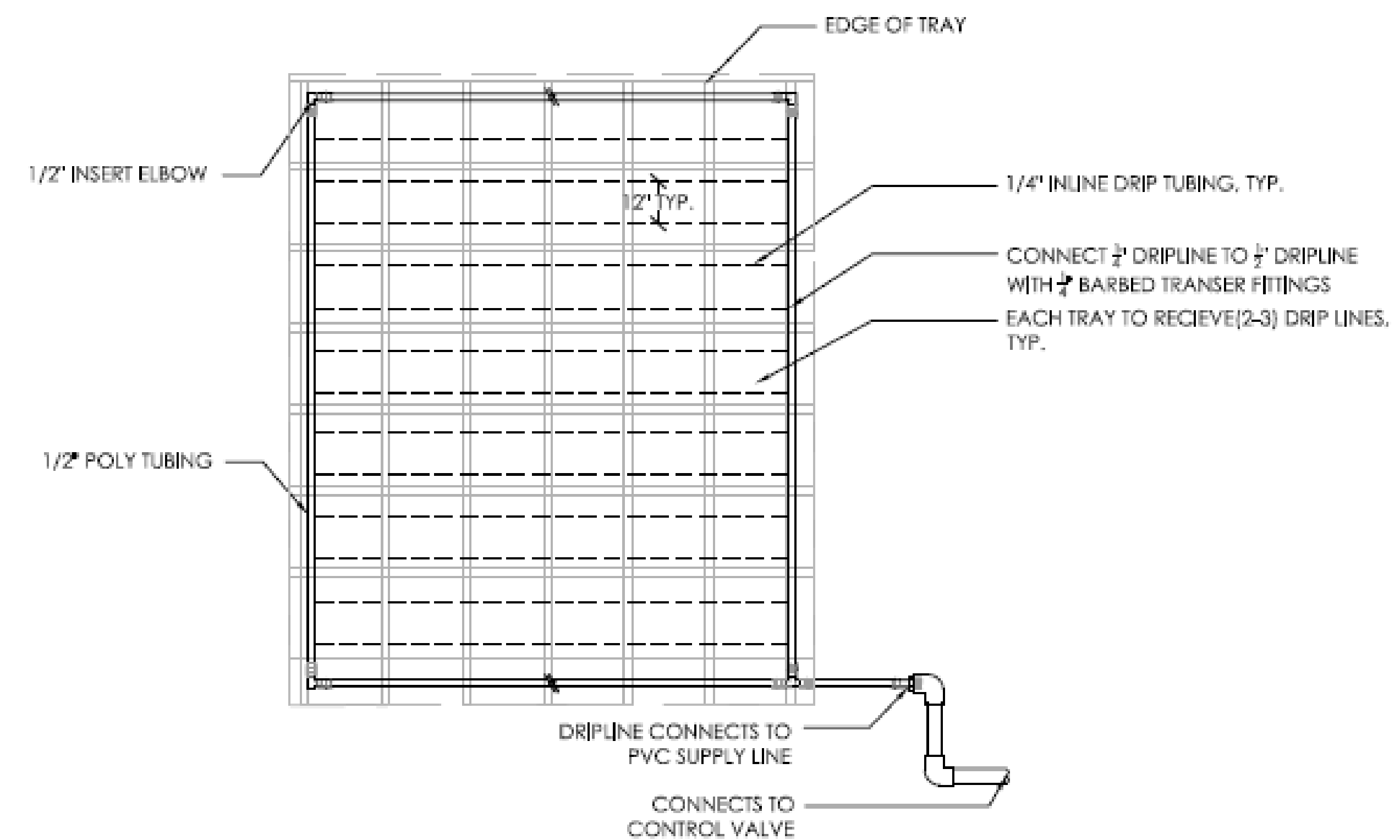

2 DRIP IRRIGATION LAYOUT
NTS

By:
GLT International, LLC
1151 Titus Avenue Ste 1
Rochester New York 14617
www.agreenroof.com 800-631-8001

greenliving
technologies glt
www.agreenroof.com

PAGE 2 OF 3

SCALE: NONE

PAGE 2 OF 3

IRRIGATION
LAYOUT

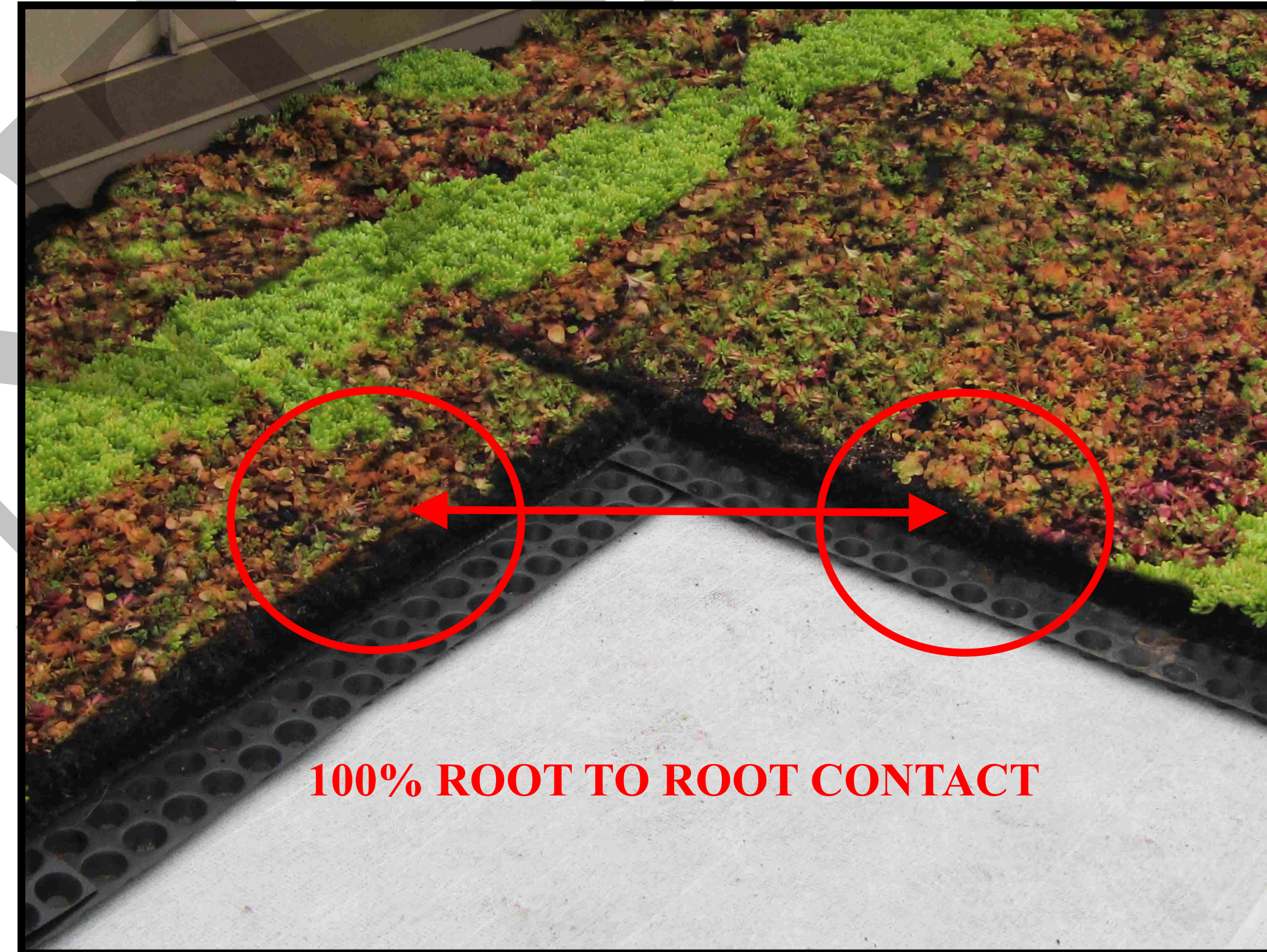

1. Sedum floriferum 'Weienstaphaner Gold'
2. Sedum kamtshaticum
3. Sedum reflexsum
4. Sedum sexangulare
5. Sedum spurium 'Fuldaglut'



Sedum floriferum 'Weienstaphaner Gold'



Sedum kamtshaticum



Sedum reflexsum



Sedum sexangulare



Sedum spurium 'Fuldaglut'



By:
GLT International, LLC
 151 Titus Avenue Ste 1
 Rochester New York 14617
 www.agreenroof.com 800-631-8001

greenliving
 technologies 
 www.agreenroof.com

		SCALE: NONE
--	--	-------------

PRE-GROWN

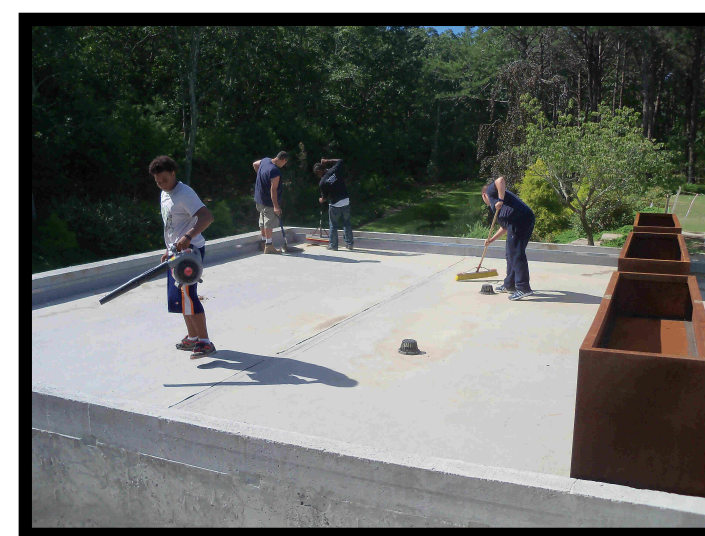

Clean Roof Deck



Slip Sheet per spec

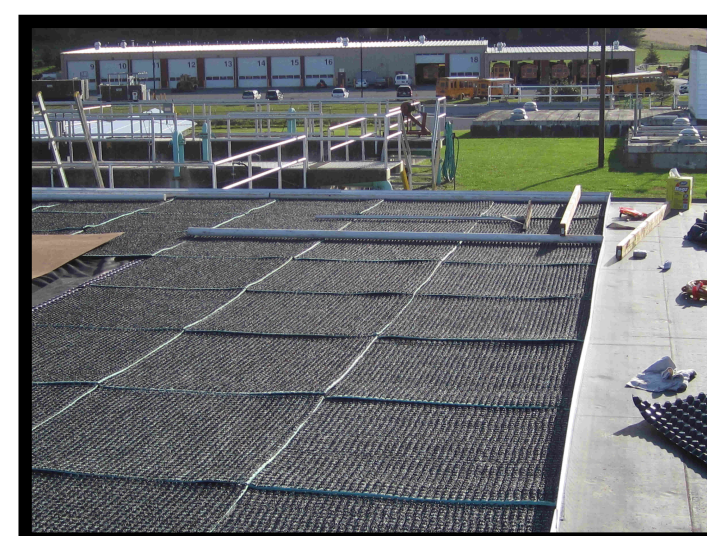

Install Panels



Screed Growing Media to Spec
*DO NOT Exceed Loading



Pre-Grown Mats
*Optional Irrigation



3/4 clean stone as ballast edge
*Option pending detail



PRE-GROWN - GLTi Mats

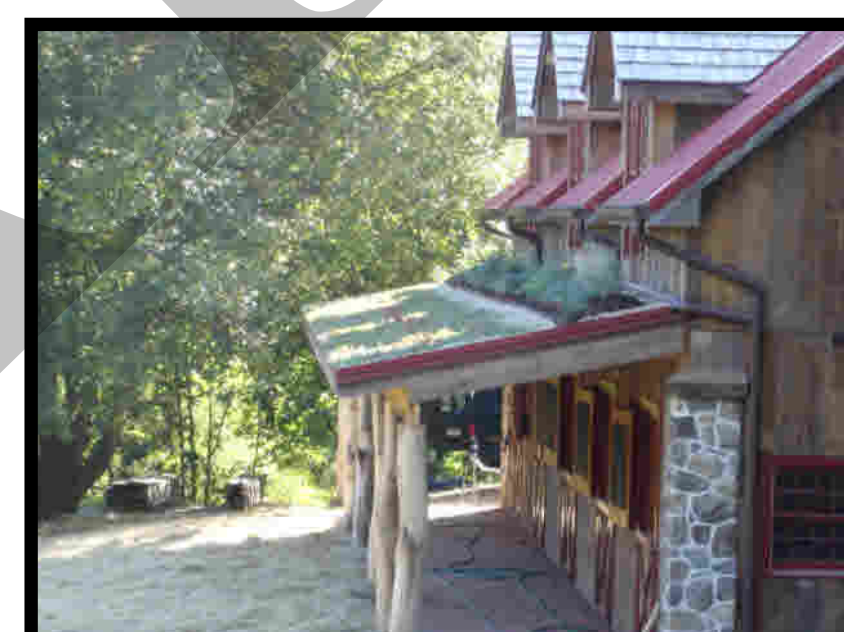
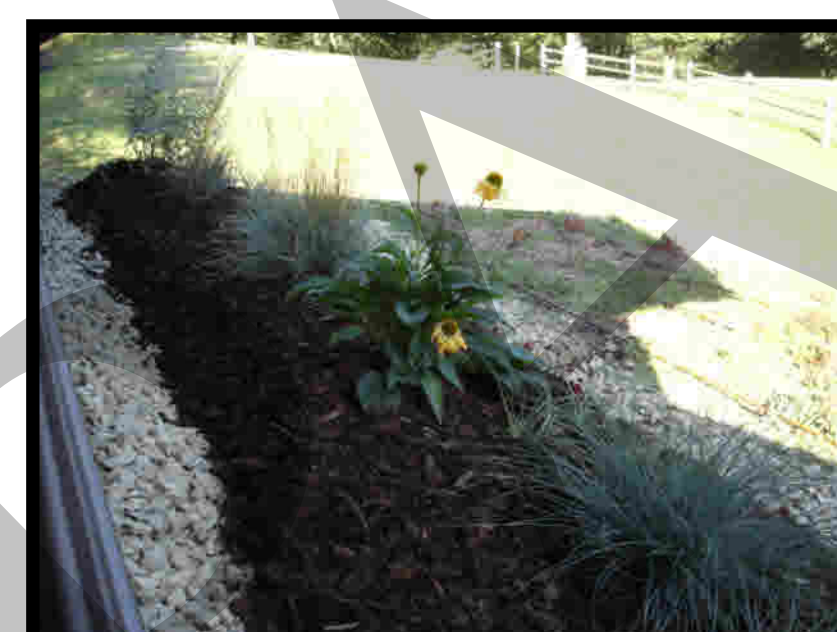
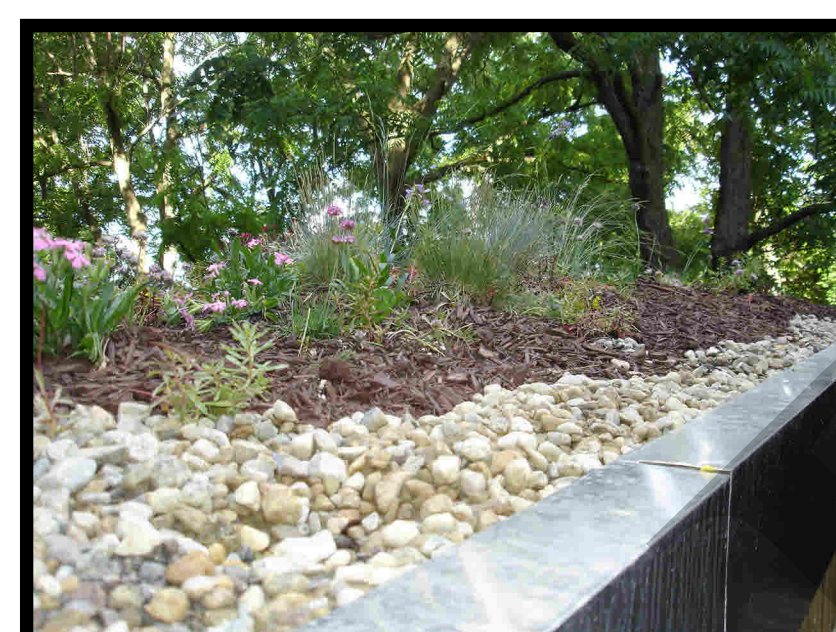

Deeper Rooted Perennials or Edible Gardens

By:
GLT International, LLC
151 Titus Avenue Ste 1
Rochester New York 14617
www.agreenroof.com 800-631-8001

greenliving
technologies 
www.agreenroof.com

SCALE: NONE